

# GP

## EXTERNAL GEAR PUMPS

### SERIES 20

#### OPERATING PRINCIPLE

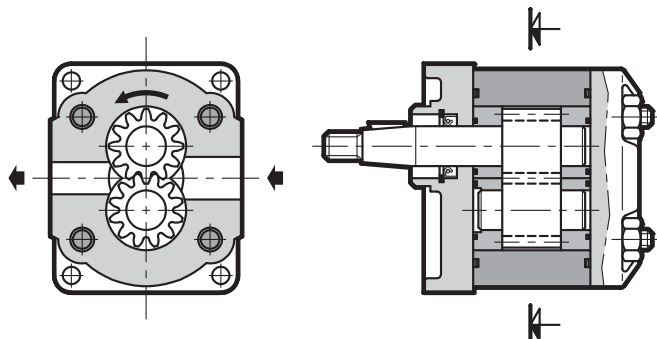

- The GP pumps are fixed displacement external gear pumps with axial clearance compensation.
- They give high volumetric flows even with high operating pressures, a low noise level, and they have a high endurance thanks to the balancing system of the loads on the guide bushings.
- They are divided into three size groups, with displacements of up to 9,1 - 27,9 and 87,6 cm<sup>3</sup>/rev respectively, and with operating pressures of up to 250 bar (standard) and up to 310 bar (version for high pressures H).
- They are available with clockwise, anticlockwise and reversible rotation, with tapered shaft (standard). Other kind of shaft are available upon request.
- They are available in multiple versions, and can be combined in multi-flow groups, with a splined connection motion system that guarantees high power performances.

#### TECHNICAL SPECIFICATIONS

GP PUMP SIZE		GP1	GP2	GP3
Displacement range	cm <sup>3</sup> /rev	1.3 ÷ 9.1	7 ÷ 27.9	20.7 ÷ 87.6
Flow rate and operating pressures		see table 3 - Performances		
Rotation speed		see table 3 - Performances		
Rotation direction		clockwise, anticlockwise or reversible (seen from the shaft side)		
Loads on the shaft		radial and axial load are not allowed		
Max torque applicable to the shaft		see paragraph 14.1		
Hydraulic connection		flanged fittings (see paragraph 16)		
Type of mounting		4 hole flange - rectangular type		
Mass: standard version version H	kg	1.2 ÷ 1.6 1.9 ÷ 2.3	2.6 ÷ 3.5 3.8 ÷ 4.7	6 ÷ 8.5 8.7 ÷ 11.2

Ambient temperature range	°C	-20 / +50
Fluid temperature range	°C	-15 / +80
Fluid viscosity range		see paragraph 2.2
Fluid contamination degree		see paragraph 2.3
Recommended viscosity	cSt	25 ÷ 100

#### HYDRAULIC SYMBOL

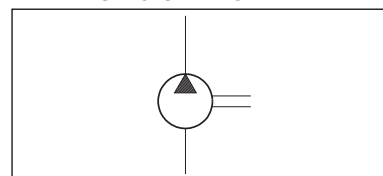



**1 - IDENTIFICATION CODE**

**1.1 - Identification code for single and front pumps**

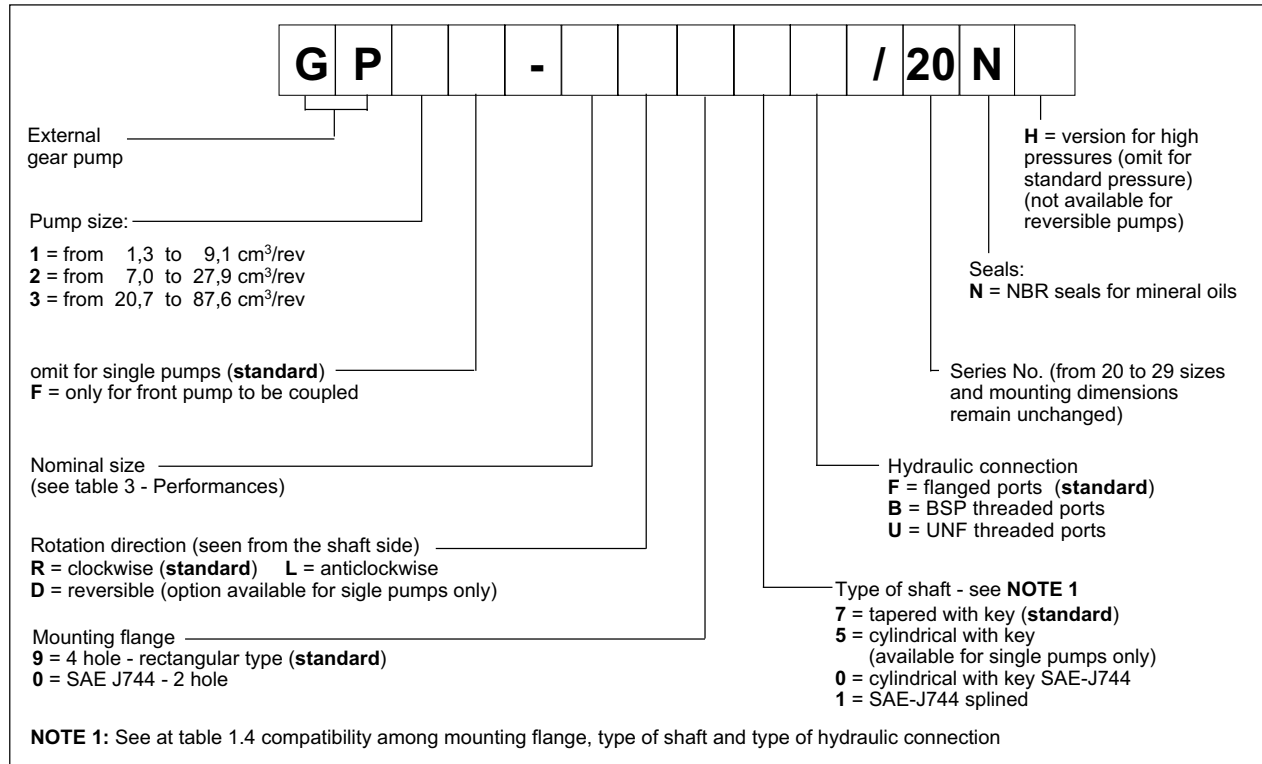

**1.2 - Identification code for intermediate and rear pumps**

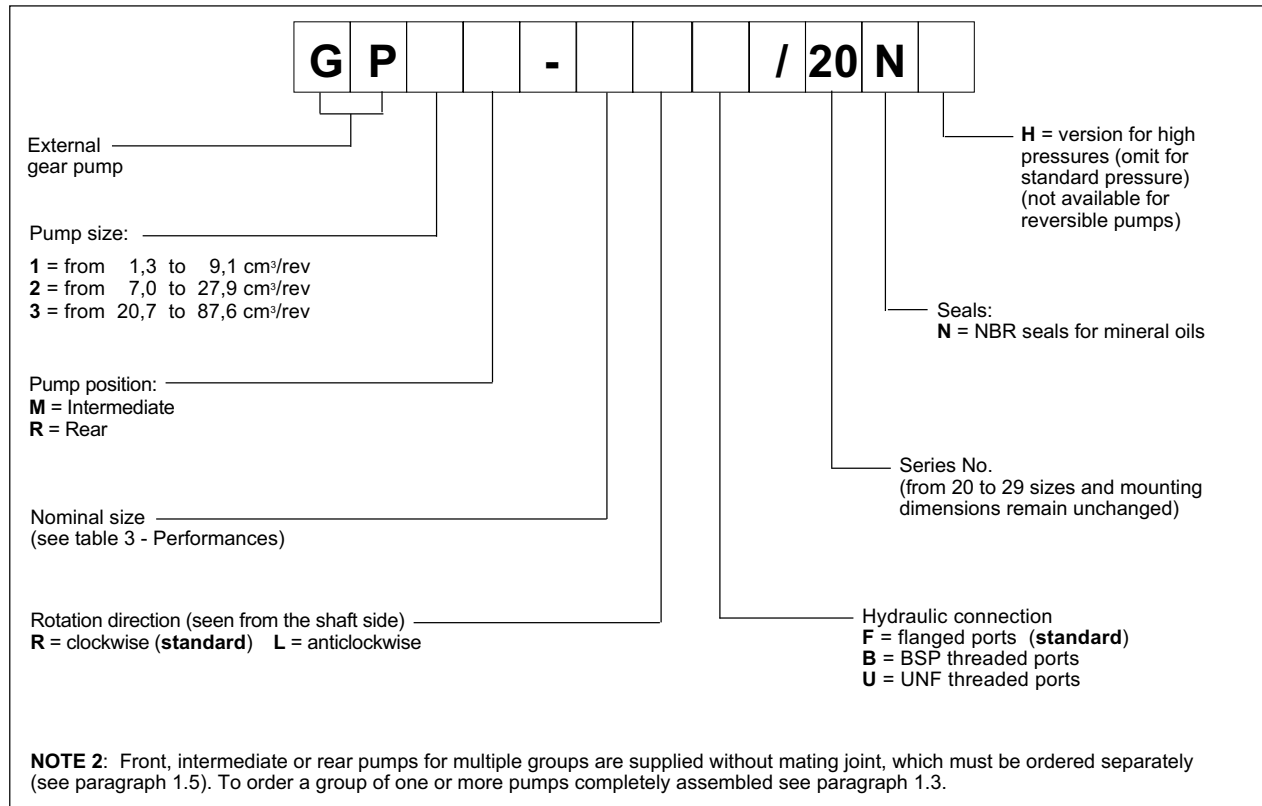



### 1.3 - Identification code for multiple pumps

identification code front pump      +      identification code intermediate pump (omit for double pumps)      +      identification code rear pump

### 1.4 - Compatibility among mounting flange, type of shaft and type of hydraulic connection

FLANGE CODE	SHAFT CODE				HYDRAULIC CONNECTION CODE		
	7	5	0	1	F	B	U
9	yes	yes	no	no	yes	yes	no
0	no	no	yes	no	yes	no	yes

### 1.5 - Identification code for mating joints

FIRST PUMP	SECOND PUMP		
	GP1	GP2	GP3
GP1	3101100003	-	-
GP2	3101100004	3101100005	-
GP3	3101100006	3101100007	3101100008

### 1.6 - Examples

- a) single pump size 1 - 1,3 cm<sup>3</sup>/rev - anticlockwise rotation - standard flange and shaft  
**GP1-0013L97F/20N**
- b) single pump size 2 - 14 cm<sup>3</sup>/rev - clockwise rotation - standard flange and shaft  
**GP2-0140R97F/20N**
- c) single pump size 3 - 22,5 cm<sup>3</sup>/rev - clockwise rotation - SAE flange and shaft  
**GP3-0225R01F/20N**
- d) double pump made of: - pump size 2 - 7 cm<sup>3</sup>/rev  
- pump size 1 - 2 cm<sup>3</sup>/rev - high pressure  
**GP2F-0070R97F/20N + GP1R-0020RF/20NH**
- e) triple pump made of: - pump size 3 - 22,5 cm<sup>3</sup>/rev  
- pump size 2 - 14 cm<sup>3</sup>/rev  
- pump size 1 - 2 cm<sup>3</sup>/rev  
**GP3F-0225R97F/20N + GP2M-0140RF/20N + GP1R-0020RF/20N**

## 2 - HYDRAULIC FLUID

### 2.1 Type of fluid

Use mineral oil based hydraulic fluids with anti-foam and antioxidant additives, in conformity with the requisites of the following standards:

- FZG test - 11th stage
- DIN 51525
- VDMA 24317

For use with other types of fluid (water glycol, phosphate esters and others), consult our technical dept.

Operation with fluid at a temperature greater than 80°C causes a premature deterioration of the fluid quality and of the seals. The physical and chemical properties of the fluid must be maintained.

### 2.2 - Fluid viscosity

The operating fluid viscosity must be within the following range:

minimum viscosity	12 cSt	referred to the maximum fluid temperature of 80 °C
optimum viscosity	25 ÷ 100 cSt	referred to the operating temperature of the fluid in the tank
maximum viscosity	600 cSt	limited to only the start-up phase of the pump



### 2.3 - Degree of fluid contamination

The maximum degree of fluid contamination must be according to ISO 4406:1999 class 20/18/15; therefore, use of a filter with  $\beta_{20} \geq 75$  is recommended. A degree of maximum fluid contamination according to ISO 4406:1999 class 18/16/13 is recommended for optimum endurance of the pump. Hence, use of a filter with  $\beta_{10} \geq 100$  is recommended.

If there is a filter installed on the suction line, be sure that the pressure at the pump inlet is not lower than the values specified in paragraph 13. The suction filter must be equipped with a by-pass valve and, if possible, with a clogging indicator.

### 3 - PERFORMANCE RATINGS (values obtained with mineral oil with viscosity of 36 cSt at 50°C)

The nominal dimensions indicated in the table are those available for standard pumps.

PUMP SIZE	NOMINAL SIZE	DISPLACEMENT [cm <sup>3</sup> /rev]	MAX FLOW RATE (at 1500 rpm) [l/min.]	MAX OPERATING PRESSURE (at 1500 rpm) [bar]	MAX PEAK PRESSURE (at 1500 rpm) [bar]	MAX ROTATION SPEED [rpm]	MIN ROTATION SPEED [rpm]
GP1	0013	1,3	2,0	250 (270)	290 (310)	6000	800
	0020	2,0	3,0				
	0027	2,7	4,0			5000	
	0034	3,4	5,1				
	0041	4,1	6,1	230 (260)	260 (290)	4000	
	0051	5,1	7,6			3800	
	0061	6,1	9,1				
	0074	7,4	11,1	200	230	3200	600
	0091	9,1	13,6	180	210	2600	
GP2	0070	7,0	10,5	250 (280)	290 (310)	4000	600
	0095	9,5	14,2			3000	
	0113	11,3	16,9	230 (260)	270 (300)	4000	
	0140	14,0	21,0				
	0158	15,8	23,7	210 (260)	240 (290)	3600	500
	0178	17,8	26,7				
	0208	20,8	31,2	180 (230)	210 (260)	3200	
	0234	23,4	35,1				
	0279	27,9	41,8	170 (200)	200 (230)	2500	
GP3	0207	20,7	31,0	230 (280)	270 (310)	3500	500
	0225	22,5	33,7				
	0264	26,4	39,6				
	0337	33,7	50,5			3000	
	0394	39,4	59,1	220 (260)	260 (290)	2800	400
	0427	42,7	64,0	210 (250)	250 (280)		
	0514	51,4	77,1	200 (230)	240 (260)		
	0600	60,0	90,0	190	220		
	0696	69,6	104,4	170	200		
	0776	77,6	116,4	160	190		
	0876	87,6	131,4	140	170		
0876	87,6	131,4	140	170	2000		

**NOTE:** The values in parentheses refer to the version **H**, for high pressures.



### 4 - CURVES AND CHARACTERISTIC DATA OF GROUP GP1 PUMPS (values obtained with mineral oil with viscosity of 36 cSt at 50°C)

#### 4.1 - Flow rate curves $Q=f(n)$ obtained with operating pressure 0 bar

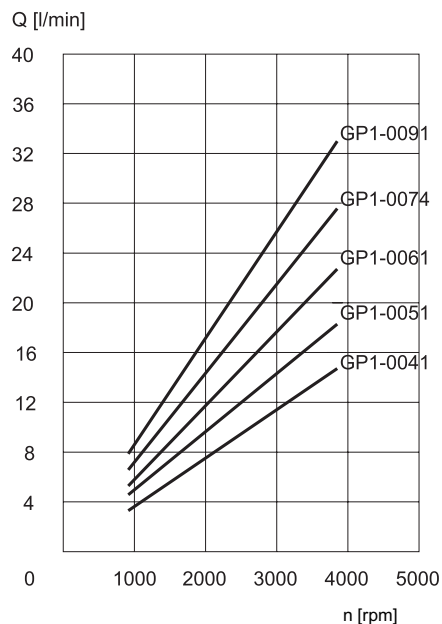
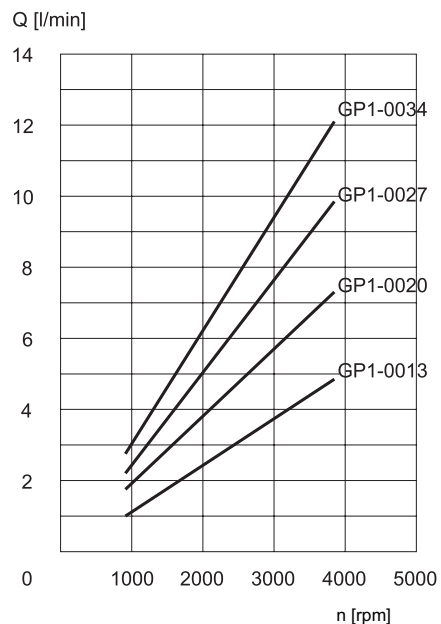

#### 4.2 - Efficiencies

PUMP NOMINAL SIZE	VOLUMETRIC EFFICIENCY [%]	TOTAL EFFICIENCY [%]
0013	0,90	0,82
0020	0,90	0,85
0027	0,95	0,90
0034	0,91	0,87
0041	0,94	0,90
0051	0,96	0,92
0061	0,96	0,92
0074	0,96	0,90
0091	0,96	0,88

The volumetric and total efficiencies for the various nominal dimensions of the Group GP1 pumps, measured at 1500 rpm and with 150 bar operating pressure, are shown in the table.

The total efficiency considers the volumetric efficiency and the mechanical efficiency of the pump in the specified operating conditions.

#### 4.3 - Noise level

PUMP NOMINAL SIZE	NOISE LEVEL [dB (A)]
0013	65
0020	66
0027	68
0034	68
0041	70
0051	73
0061	73
0074	73
0091	77

The noise levels for the various nominal dimensions of the Group GP1 pumps, measured at 1500 rpm, with 150 bar operating pressure and measured at a distance of 1 metre from the pump, are shown in the table.



#### 4.4 - Absorbed power curves $N=f(n)$ , measured with operating pressures from 50 to 250 bar

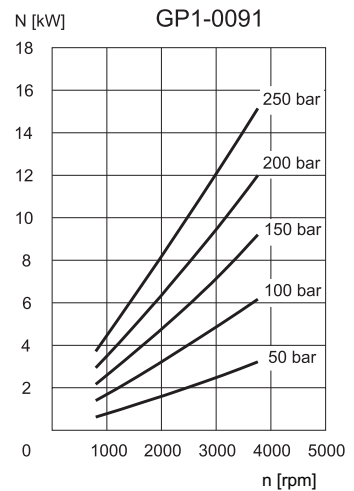
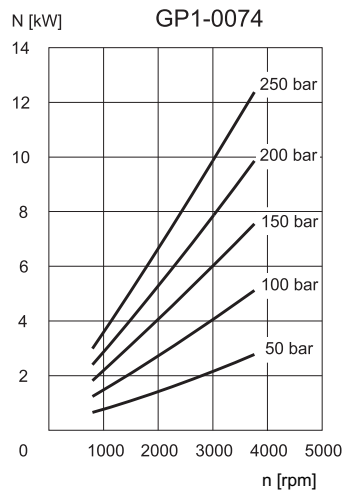
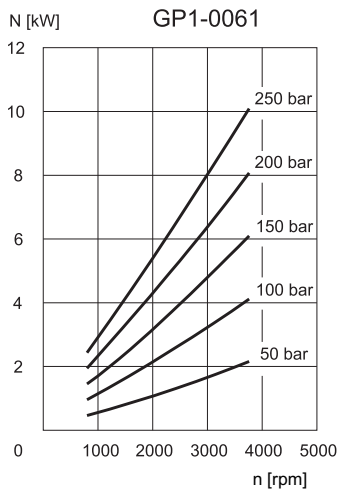
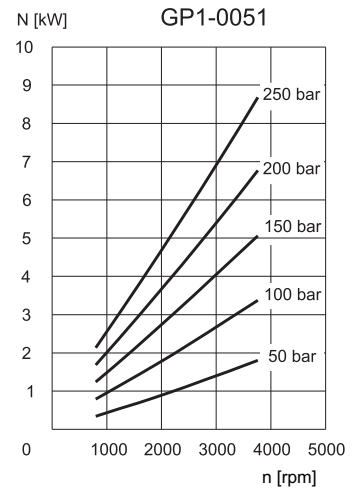
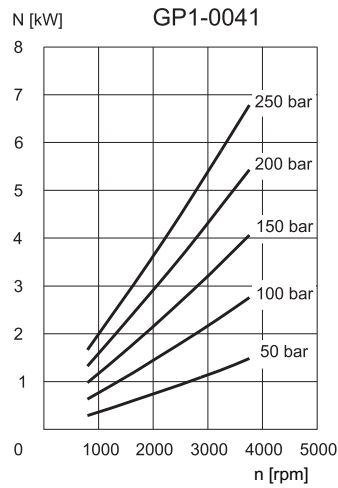
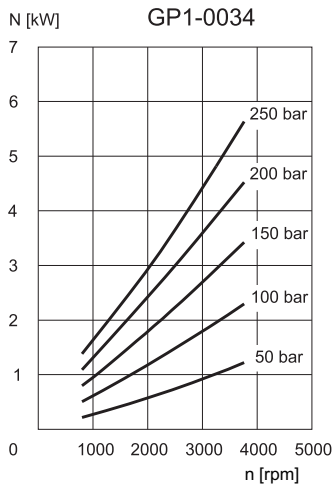
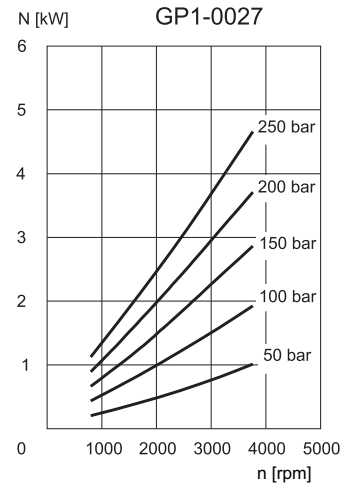
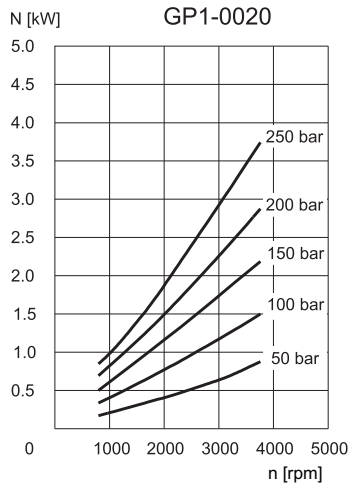
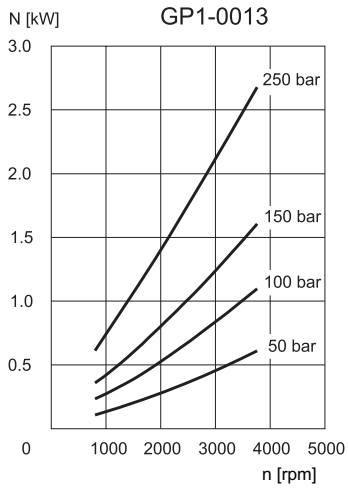



### 5 - CURVES AND CHARACTERISTIC DATA OF GROUP GP2 PUMPS (values obtained with mineral oil with viscosity of 36 cSt at 50°C)

#### 5.1 - Flow rate curves $Q=f(n)$ obtained with operating pressure 0 bar

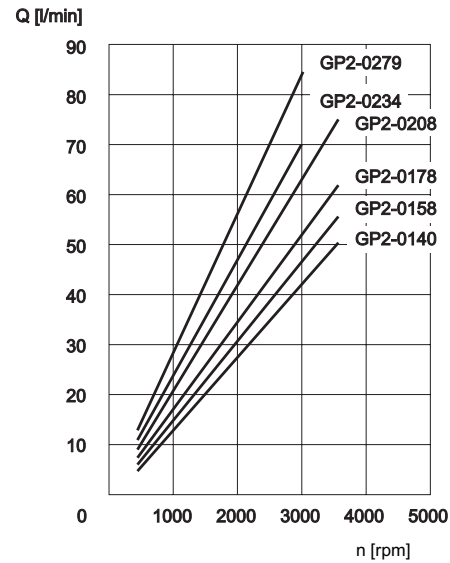
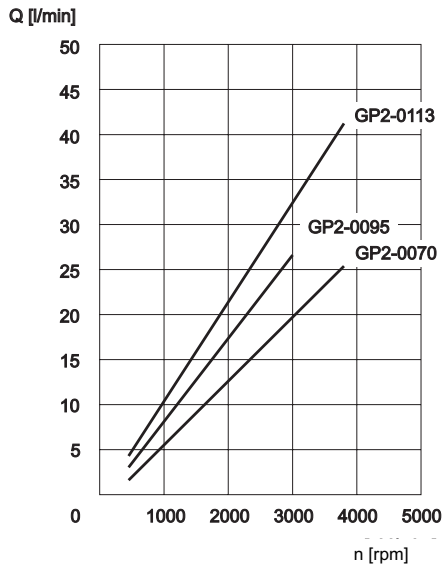

#### 5.2 - Efficiencies

PUMP NOMINAL SIZE	VOLUMETRIC EFFICIENCY [%]	TOTAL EFFICIENCY [%]
0070	0,92	0,87
0095	0,95	0,88
0113	0,95	0,87
0140	0,93	0,87
0158	0,95	0,86
0178	0,93	0,85
0208	0,93	0,88
0234	0,97	0,89
0279	0,94	0,85

The volumetric and total efficiencies for the various nominal dimensions of the Group GP2 pumps, measured at 1500 rpm and with 150 bar operating pressure, are shown in the table.

The total efficiency considers the volumetric efficiency and the mechanical efficiency of the pump in the specified operating conditions.

#### 5.3 - Noise level

PUMP NOMINAL SIZE	NOISE LEVEL [dB (A)]
0070	75
0095	77
0113	77
0140	72
0158	72
0178	73
0208	74
0234	76
0279	76

The noise levels for the various nominal dimensions of the Group GP2 pumps, measured at 1500 rpm, with 150 bar operating pressure and measured at a distance of 1 metre from the pump, are shown in the table.



### 5.4 - Absorbed power curves $N=f(n)$ , measured with operating pressures from 50 to 250 bar

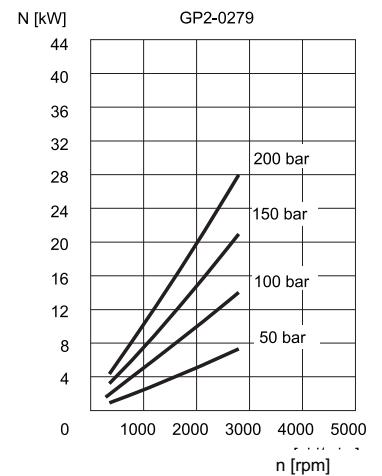
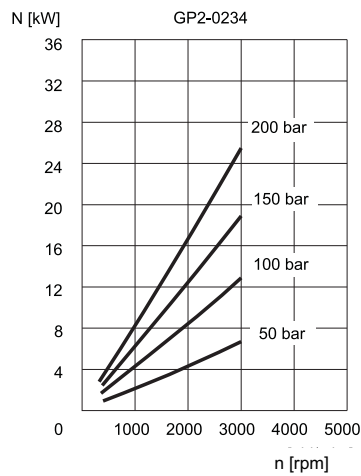
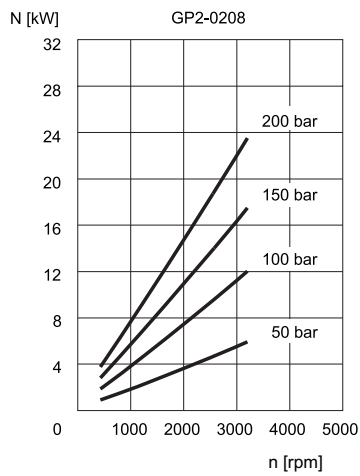
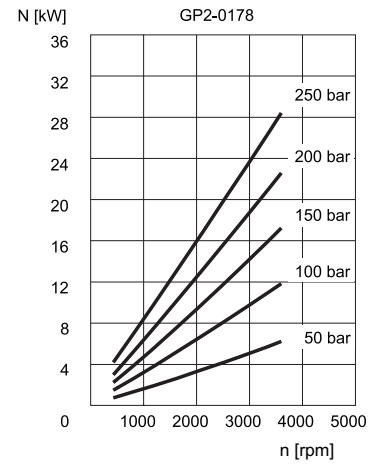
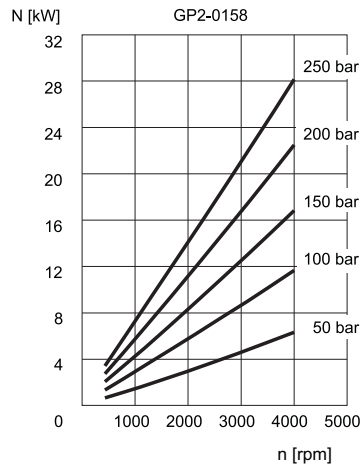
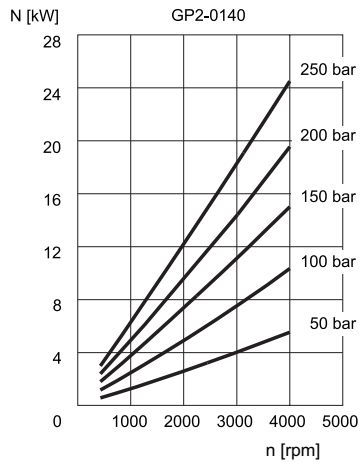
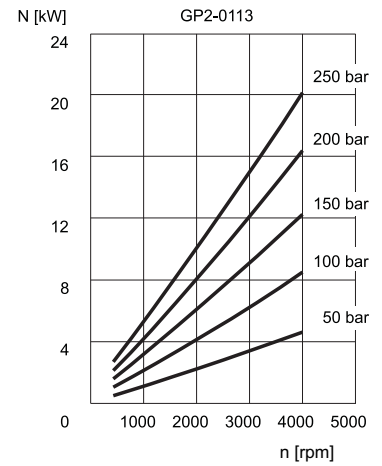
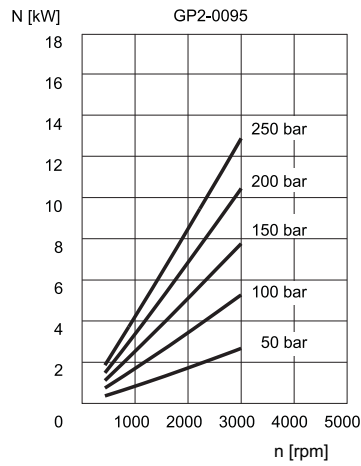
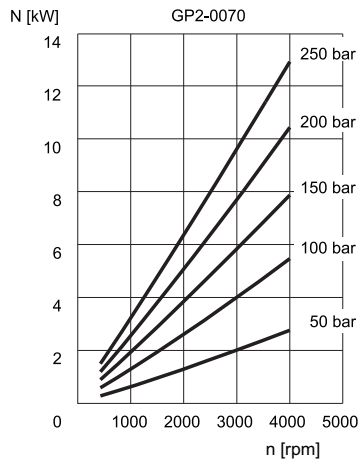





**6 - CURVES AND CHARACTERISTIC DATA OF GROUP GP3 PUMPS** (values obtained with mineral oil with viscosity of 36 cSt at 50°C)

**6.1 - Flow rate curves  $Q=f(n)$**  obtained with operating pressure 0 bar

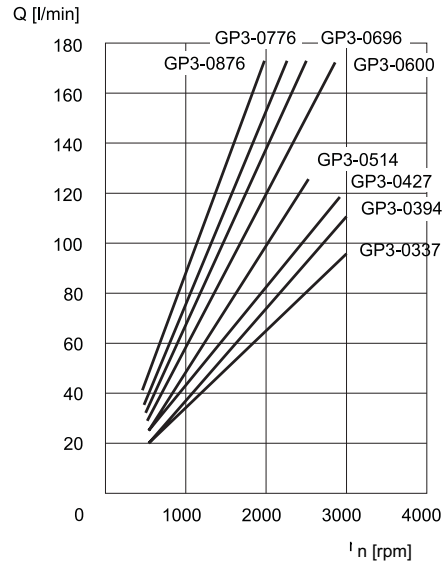
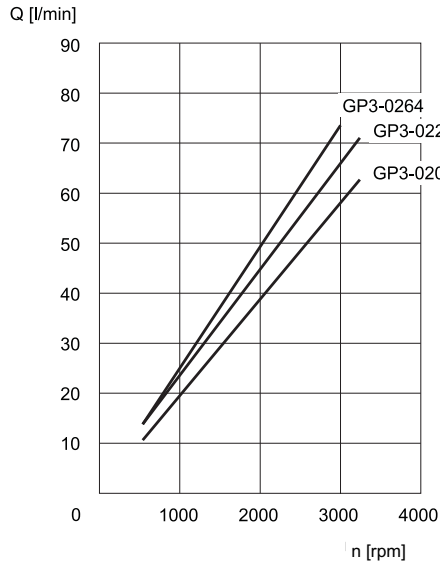

**6.2 - Efficiencies**

PUMP NOMINAL SIZE	VOLUMETRIC EFFICIENCY [%]	TOTAL EFFICIENCY [%]
0207	0,88	0,83
0225	0,97	0,92
0264	0,90	0,84
0337	0,92	0,87
0394	0,91	0,86
0427	0,92	0,82
0514	0,93	0,83
0600	0,85	0,82
0696	0,95	0,90
0776	0,93	0,87
0876	0,89	0,84

The volumetric and total efficiencies for the various nominal dimensions of the Group GP3 pumps, measured at 1500 rpm and with 150 bar operating pressure, are shown in the table.

The total efficiency considers the volumetric efficiency and the mechanical efficiency of the pump in the specified operating conditions.

**6.3 - Noise level**

PUMP NOMINAL SIZE	NOISE LEVEL [dB (A)]
0207	75
0225	75
0264	76
0337	72
0394	72
0427	73
0514	75
0600	77
0696	77
0776	76
0876	78

The noise levels for the various nominal dimensions of the Group GP3 pumps, measured at 1500 rpm, with 150 bar operating pressure and measured at a distance of 1 metre from the pump, are shown in the table.



## 6.4 - Absorbed power curves $N=f(n)$ , measured with operating pressures from 50 to 250 bar

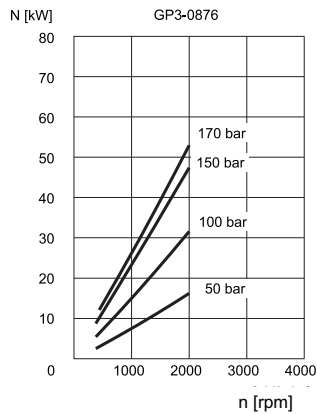
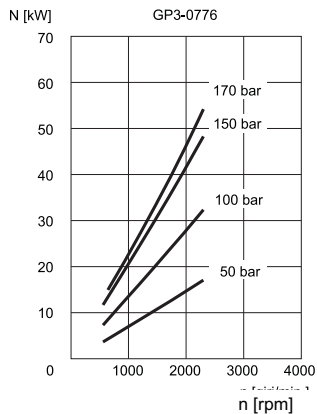
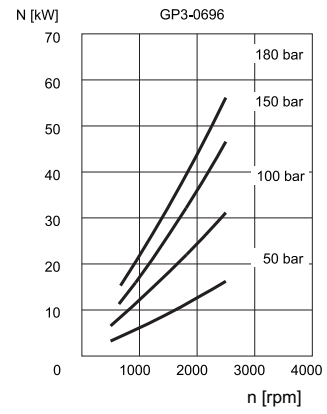
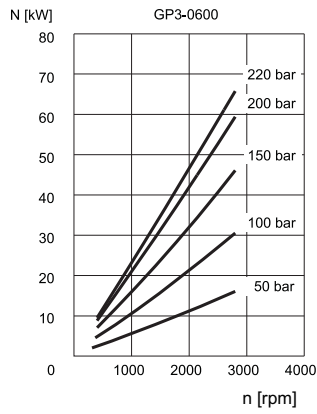
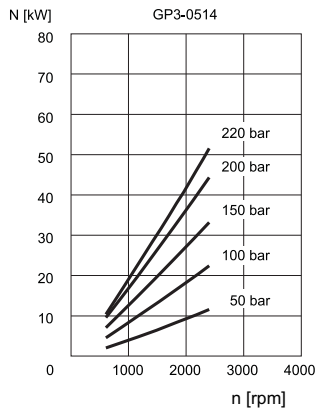
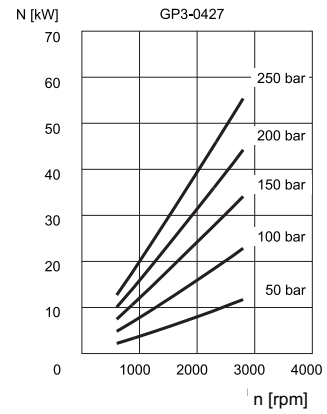
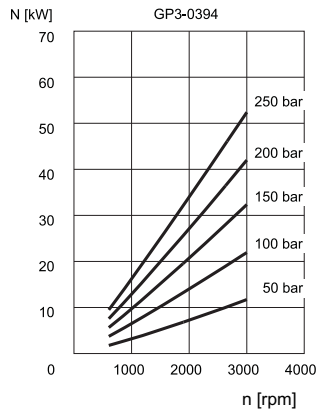
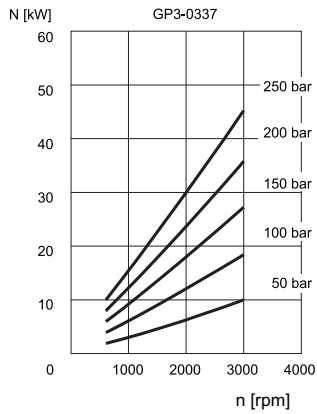
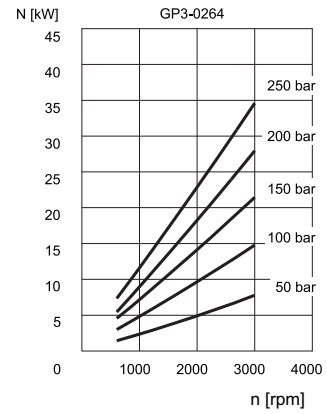
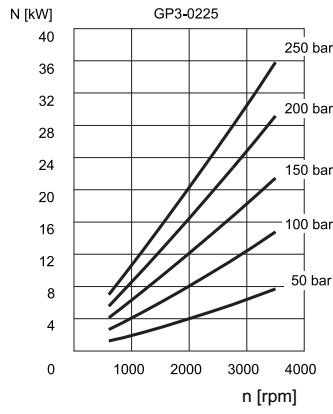
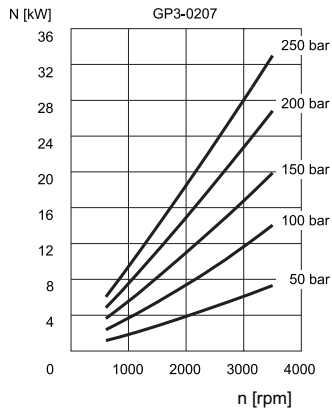



**7 - GROUP GP1 PUMPS OVERALL AND MOUNTING DIMENSIONS with standard flange**

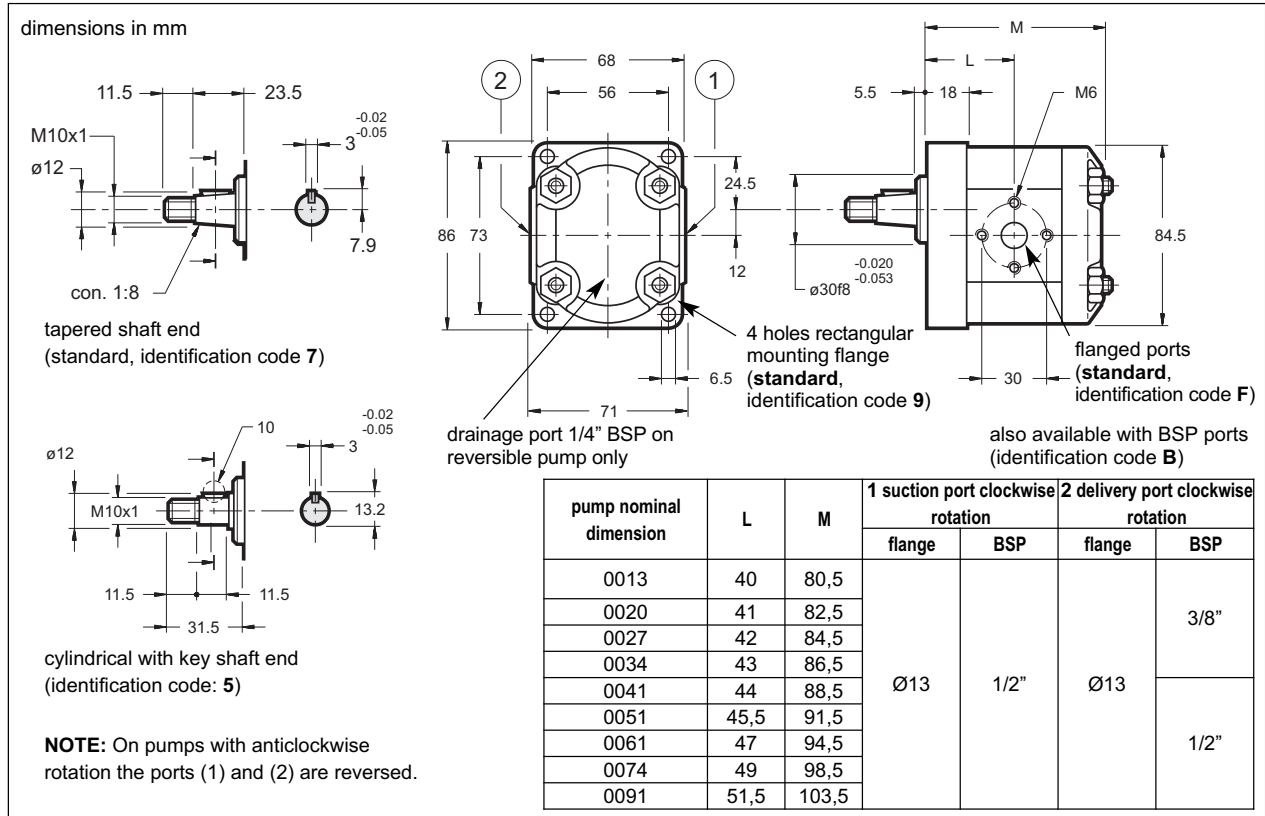

**8 - GROUP GP1 PUMPS OVERALL AND MOUNTING DIMENSIONS with SAE flange**

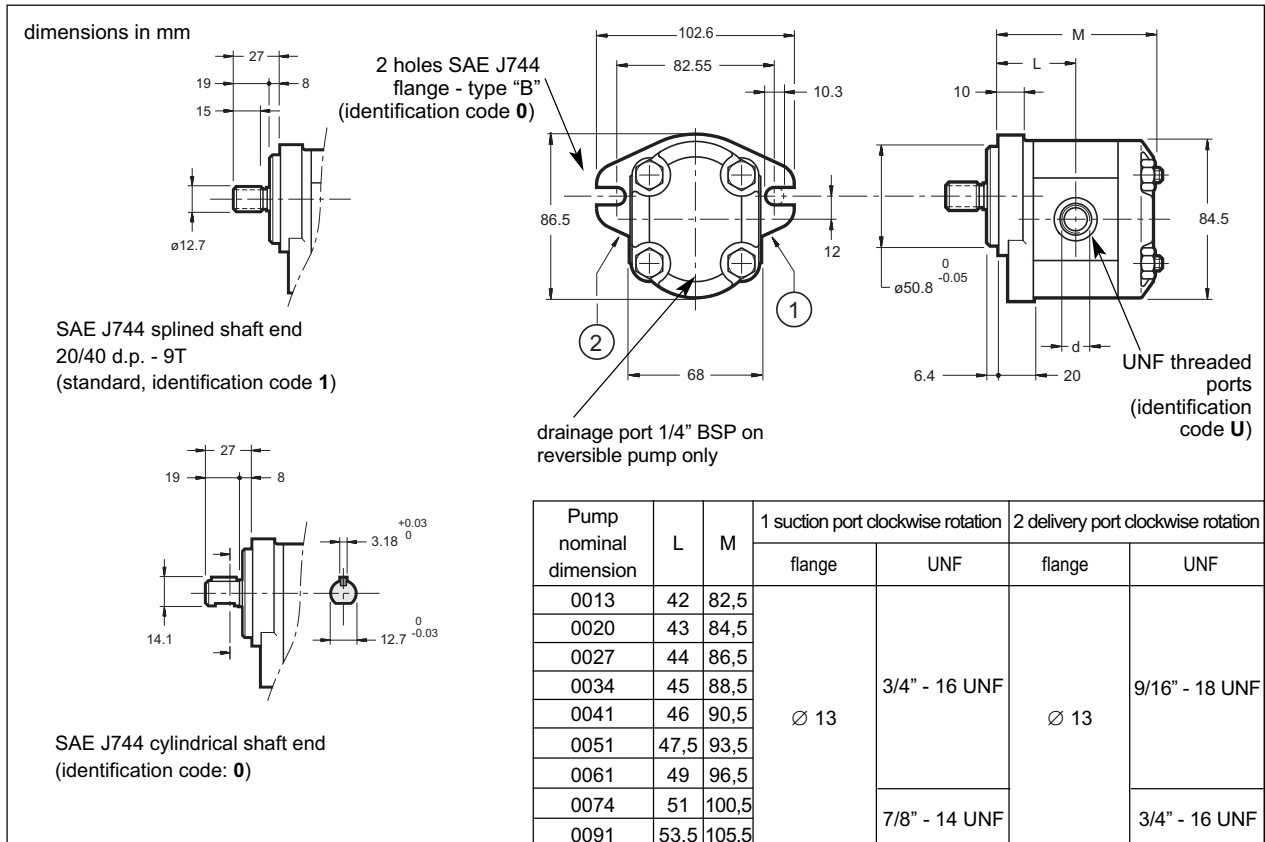



**9 - GROUP GP2 PUMPS OVERALL AND MOUNTING DIMENSIONS with standard flange**

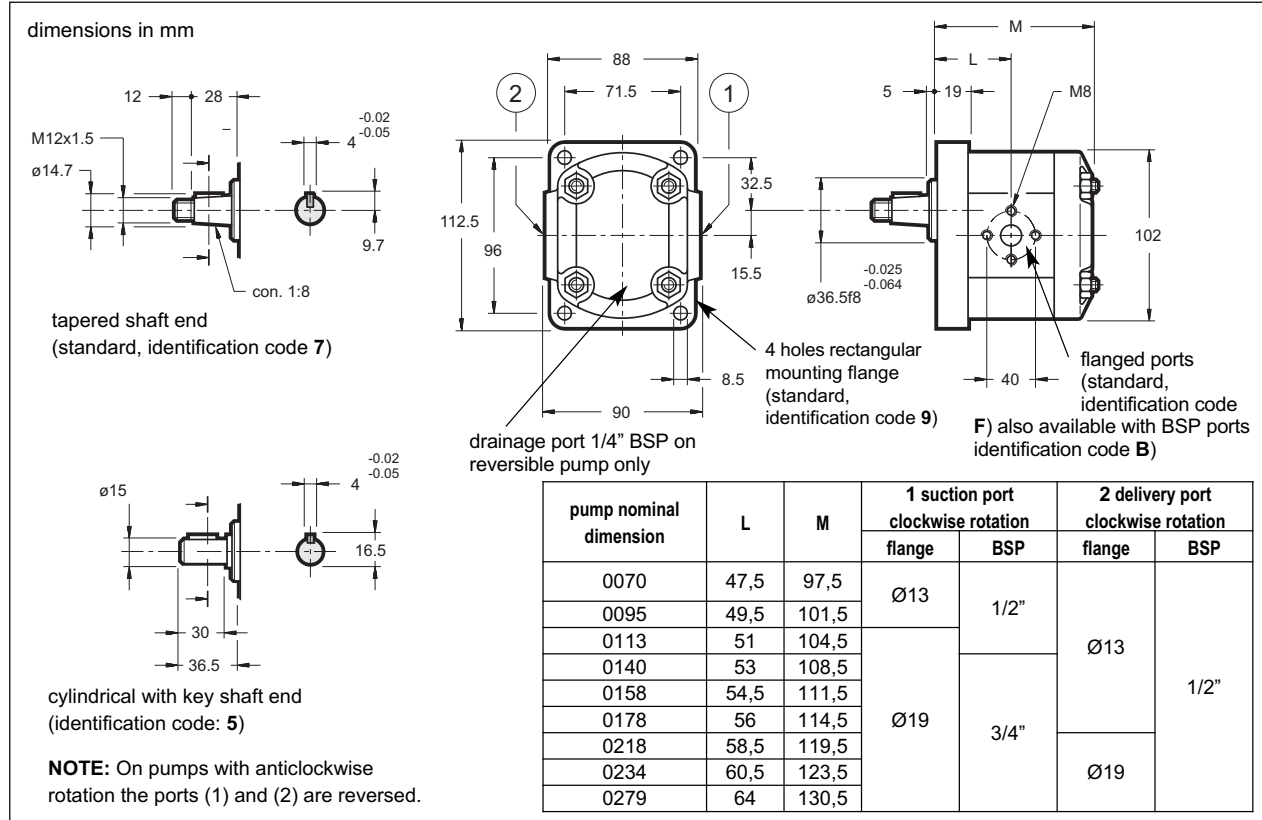

**10 - GROUP GP2 PUMPS OVERALL AND MOUNTING DIMENSIONS with SAE flange**

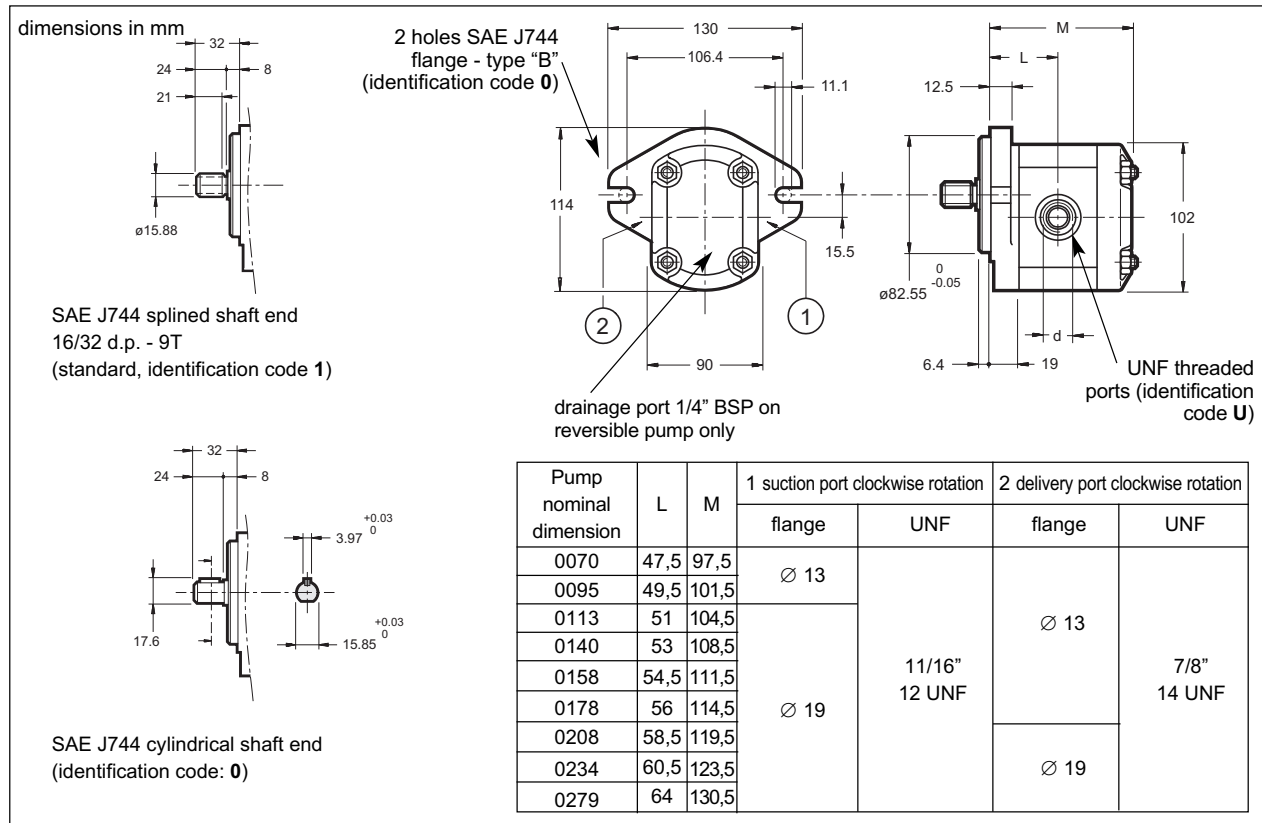



11 - GROUP GP3 PUMPS OVERALL AND MOUNTING DIMENSIONS with standard flange

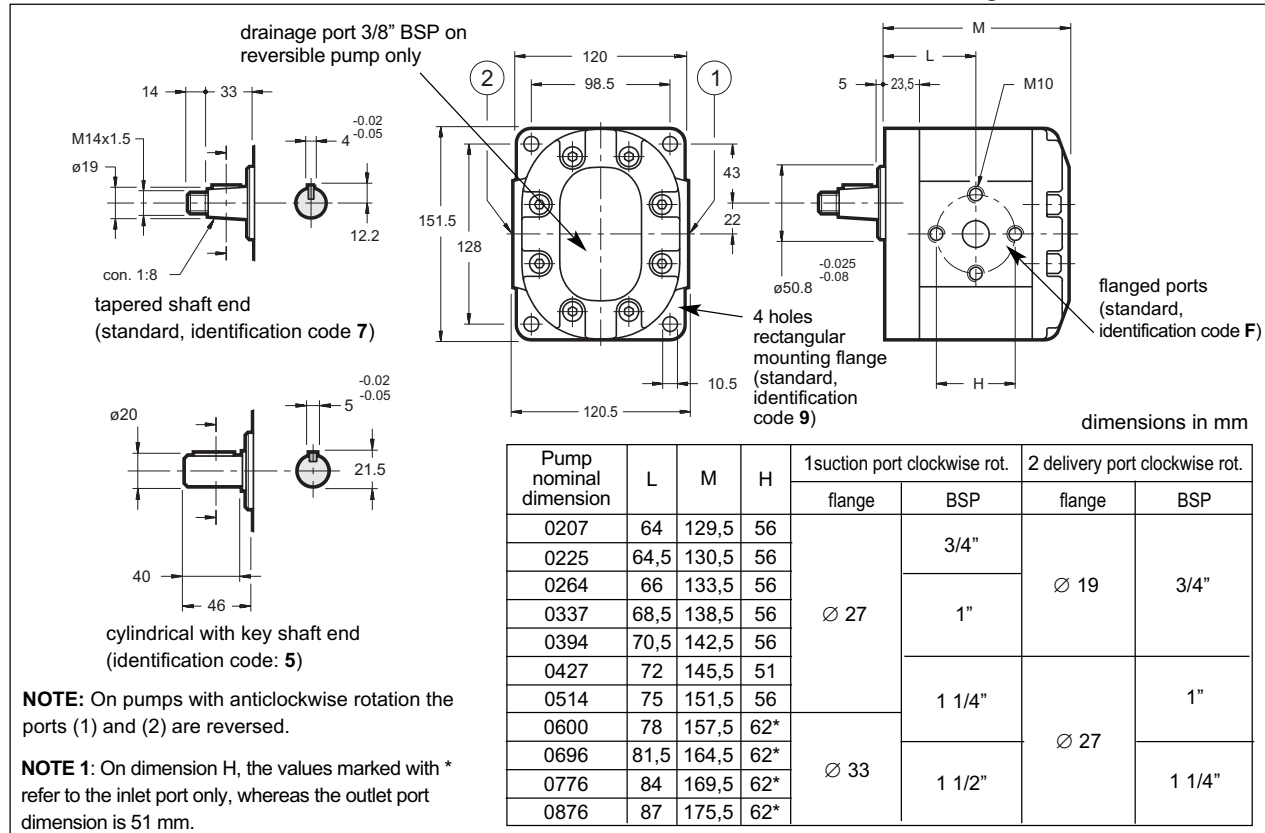

12 - GROUP GP3 PUMPS OVERALL AND MOUNTING DIMENSIONS with SAE flange

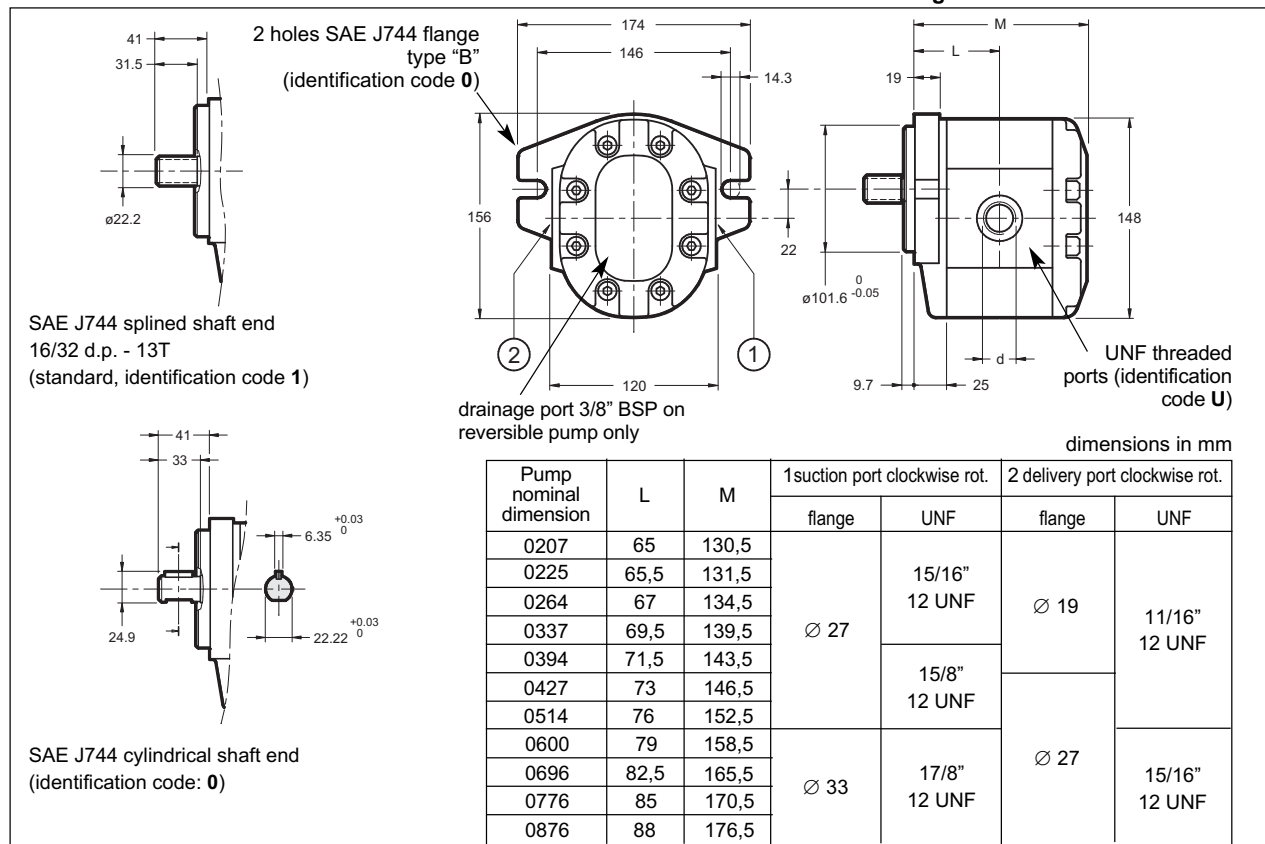



### 13 - INSTALLATION

- The GP gear pumps can be installed with the shaft oriented in any position.
- Be sure the control rotation direction corresponds to the direction of the arrow marked on the pump before putting the pump into operation.
- **Before starting, the pump body has to be filled with the fluid.**
- It is necessary to vent the air from the delivery connection before operating it the first time.
- The pump start up, especially at a cold temperature, should occur with the pump unloading.
- The suction line must be suitably sized to facility the flow of the oil. Bends and restrictions or an excessive line length can impede correct operation of the pump. It is advisable that the speed of  $1 \div 2$  m/sec is not exceeded in the suction line.
- The minimum suction pressure allowed is -0,3 bar relative. The pumps can not function with suction pressure.
- The gear pumps must not operate with a rotation rating of less than the minimum rotation speed (see table 3 - performance ratings). They must be filled with the same plant operation oil before installation. Filling is done through the connection lines. If necessary, rotate the pump manually.
- The motor-pump connection must be carried out directly with a flexible coupling able to compensate any offsets. Couplings that generate axial or radial loads on the pump shaft are not allowed.

### 14 - MULTIPLE PUMPS

The possibility to couple several pumps makes it possible to create multi-flow groups with independent hydraulic circuits. While sizing coupled pumps, it is necessary to make reference to the following conditions:

- The coupling can be carried out between pumps with the same dimensions or to a size of decreasing order.
- The max. rotation speed is determined by the pump with the lowest speed.
- The values of the max. applicabe torque can not be exceeded.

#### 14.1 - Maximum applicable torque

The input torque (M) for each pump is given by the following ratio:

$$M = \frac{9550 \cdot N}{n} = [\text{Nm}] \quad n = \text{rotation speed [rpm]}$$

where the absorbed power (N) is given by:

$$N = \frac{Q \cdot \Delta p}{600 \cdot \eta_{\text{tot}}} = [\text{kW}] \quad \begin{aligned} Q &= \text{flow rate [l/min]} \\ \Delta p &= \text{differential pressure between the pump suction and delivery [bar]} \\ \eta_{\text{tot}} &= \text{total efficiency (see diagrams in par. 4.2 - 5.2 - 6.2).} \end{aligned}$$

or it can be obtained from the diagrams ABSORBED POWER (see paragraphs 4.4 - 5.4 - 6.4).

If several pumps are coupled, the torque of each single pump has to be added to the torque of subsequent pumps when they are loaded simultaneously.

The obtained torque value for each pump has to be lower than the value specified in the table below.

If the obtained torque values are higher than the ones stated in the table, it is necessary to reduce the working pressure value or to replace the overloaded pump with a pump suitable to bear the required torque.

FRONT PUMP SIZE	MAX TORQUE APPLICABLE TO THE SHAFT OF THE FRONT PUMP [Nm]			MAX APPLICABLE TORQUE [Nm] (not simultaneously to the front pump)		
	tapered shaft with key code 7	SAE J744 splined shaft code 1	SAE J744 cylindrical shaft cod. 0	PUMP TO BE MATED		
				GP1	GP2	GP3
GP1	100	100	60	50	-	-
GP2	200	185	140		100	
GP3	300	600	450			220



### 15 - MULTIPLE PUMPS OVERALL DIMENSIONS

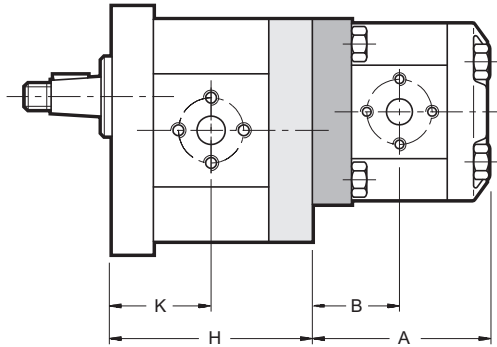

dimensions in mm

PUMP SIZE	NOMINAL SIZE	FRONT PUMP		REAR PUMP	
		H	K	A	B
GP1	0013	86	40	86,5	46
	0020	88	41	88,5	47
	0027	90	42	90,5	48
	0034	92	43	92,5	49
	0041	94	44	94,5	50
	0051	97	45,5	97,5	51,5
	0061	100	47	100,5	53
	0074	104	49	104,5	55
GP2	0091	109	51,5	109,5	57,5
	0070	101	47,5	103,5	53,5
	0095	105	49,5	107,5	55,5
	0113	108	51	110,5	57
	0140	112	53	114,5	59
	0158	115	54,5	117,5	60,5
	0178	118	56	120,5	62
	0208	123	58,5	125,5	64,5
GP3	0234	127	60,5	129,5	66,5
	0279	134	64	136,5	70
	0207	135,5	64	137	71,5
	0225	136,5	64,5	138	72
	0264	139,5	66	141	73,5
	0337	144,5	68,5	146	76
	0394	148,5	70,5	150	78
	0427	151,5	72	153	79,5
	0514	157,5	75	159	82,5
	0600	163,5	78	165	85,5
	0696	170,5	81,5	172	89
0776	175,5	84	177	91,5	
0876	181,5	87	183	94,5	

**NOTE:** For the dimensions of groups composed of three or more pumps, please consult our Technical Dept.



**16 - CONNECTION FLANGES**

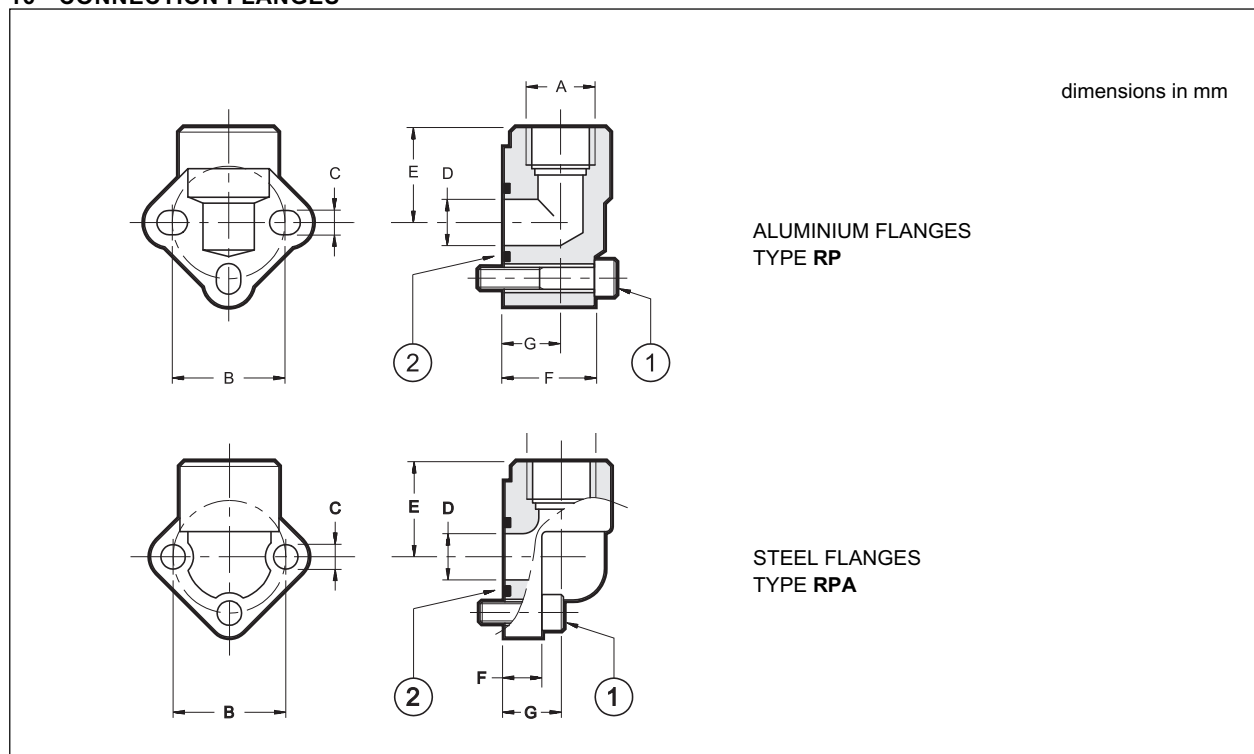

**ALUMINIUM FLANGES TYPE RP**

	Flange code	Flange description	P <sub>max</sub> [bar]	ØA	B	C	ØD	E	F	G	(1) TCEI bolts	(2) seals
GP1	0610506	RP1 - 38	180	3/8" BSP	30	6,5	12,5	30	26	18	n°3 - M6x35	OR 121 (15.88x2.62)
	0610248	RP1 - 12		1/2" BSP	30	6,5	12,5	30	26	18		
GP2	0610508	RP2 - 12		1/2" BSP	40	8,5	18,5	40	31	20	n°3 - M8x45	OR 130 (22.22x2.62)
	0610249	RP2 - 34		3/4" BSP	40	8,5	18,5	40	31	20		
GP3	0610717	RP3 - 34		3/4" BSP	51	10,5	25	46	43	26	n°3 - M10x60	OR 4118 (29.75x3.53)
	0610250	RP3 - 100		1" BSP	56	10,5	25	46	43	26		
	0610251	RP35 - 140		1"¼ BSP	62	13	32	57	17	33,5	n°2 - M12x35	OR 4143 (36.1x3.53)

**STEEL FLANGES TYPE RPA**

	Flange code	Flange description	P <sub>max</sub> [bar]	ØA	B	C	ØD	E	F	G	(1) TCEI bolts	(2) seals
GP1	0771048	RPA1 - 38	315	3/8" BSP	30	6,5	12	24	17	9,5	n°3 - M6x20	OR 121 (15.88x2.62)
	0771049	RPA1 - 12		1/2" BSP	30	6,5	12	24	17	9,5		
GP2	0771050	RPA2 - 12		1/2" BSP	40	8,5	20	36	22	11,5	n°3 - M8x25	OR 132 (23.81x2.62)
	0770615	RPA2 - 34		3/4" BSP	40	8,5	20	36	22	11,5		
GP3	0771051	RPA3 - 34A		3/4" BSP	51	10,5	24	46	26	13	n°3 - M10x30	OR 3125 (31.42x2.62)
	0770617	RPA3 - 100A		1" BSP	51	10,5	24	46	26	13		
	0770618	RPA3 - 34B		3/4" BSP	56	10,5	24	46	26	13		
	0770619	RPA3 - 100B		1" BSP	56	10,5	24	46	26	13		
	0771052	RPA35 - 114A		1" ¼ BSP	62	13	31	55	35	17	n°3 - M10x35	

 <b>DIPLOMATIC HYDRAULICS</b>	<p><b>DUPLOMATIC OLEODINAMICA SpA</b>          20025 LEGNANO (MI) - P.le Bozzi, 1 / Via Edison          Tel. 0331/472111 - Fax 0331/548328</p>
----------------------------------	--